



ISGEC Heavy Engineering Limited

Checklist for Equipment Inspection

Project Name:
Checklist No.
Make:
 ISGEC

Project Code:
Date:
Model:
 Contractor

Hired

Equipment Name & Number:	1-BACKHOE LOADER (JCB) &			
Note: Please write Yes or No in the given box and if some comments write in remarks column.				
SN.	Description	#	Yes/No	Remarks
1.	Machine should be physically good & certified by competent authority.	#		
2.	No damage in tire (Bolts, crack, cuts & air pressure, etc.).	#		
3.	Head & tail light and indicators are in working condition.	#		
4.	Side mirror should be in good condition.	#		
5.	Wind shield/glass should be in proper condition.	#		
6.	Wiper should be in running condition.			
7.	Operator cabin and driver seat should be made by good & sound quality of material.	#		
8.	Hydraulic cylinders and hoses are in good condition and free from leakage.	#		
9.	Outrigger should be free from damages.	#		
10.	Red triangle/reflective tape should be fixed in front of vehicle.			
11.	Front & reverse horn.	#		
12.	Fire extinguisher in operator cabin.	#		
13.	First aid box in operator cabin.			
14.	Operator have valid and suitable license.	#		

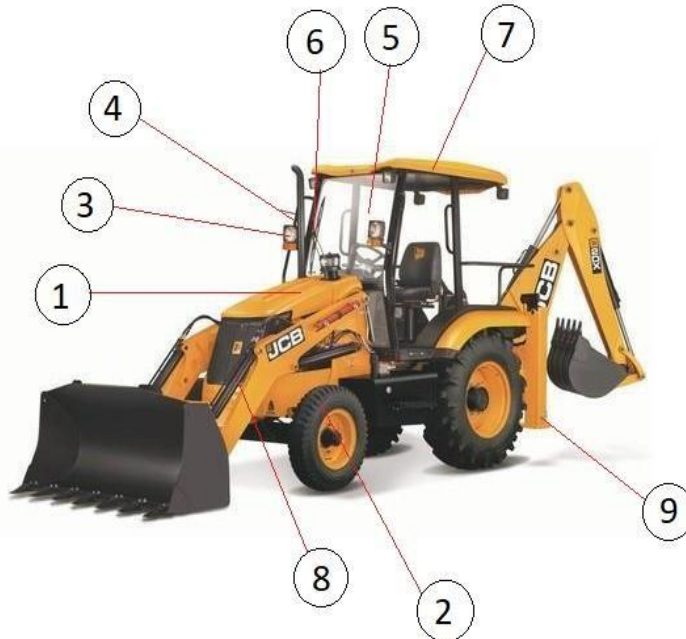

FIT <input type="checkbox"/>	PARTIALLY FIT <input type="checkbox"/>	UNFIT <input type="checkbox"/>
Inspected By	Reviewed By	
Name:	Name:	
Signature with date:	Signature with date:	



ISGEC Heavy Engineering Limited

Checklist for Equipment Inspection

Project Name:
Checklist No.
Make:
 ISGEC

Hired

Project Code:
Date:
Model:
 Contractor

Equipment Name & Number: 2-EXCAVATOR &				
Note: Please write Yes or No in the given box and if some comments write in remarks column.				
SN.	Description	#	Yes/No	Remarks
1.	Engine and rotating part should be properly covered.	#		
2.	Track frame should be in good and working condition.	#		
3.	Crawler belt and shoes should be in good condition.	#		
4.	Boom and arm should be free from defects like corrosion, bend, etc.	#		
5.	Hydraulic cylinder and hoses should be in good condition.			
6.	Bucket, cutter pins should be free from defects, e.g., damage, corrosion, bend, etc.	#		
7.	Teeth should be free from defects, e.g., damage, corrosion, bend, etc.	#		
8.	Side mirror should be in good condition.	#		
9.	Head & tail light and indicators are in working condition.	#		
10.	Wind shield/glass should be in proper condition.	#		
11.	Wiper should be in running condition.			
12.	Swing horn should be in good condition.			
13.	Fire extinguisher in operator cabin.			
14.	Operator have suitable licence/experience certificate.	#		



FIT <input type="checkbox"/>	PARTIALLY FIT <input type="checkbox"/>	UNFIT <input type="checkbox"/>
Inspected By		Reviewed By
Name:		Name:
Signature with date:		Signature with date:



ISGEC Heavy Engineering Limited

Checklist for Equipment Inspection

Project Name:
Checklist No.
Make:
 ISGEC

Project Code:
Date:
Model:
 Contractor

Hired

Equipment Name & Number:		3-DUMPER &		
Note: Please write Yes or No in the given box and if some comments write in remarks column.				
SN.	Description		Yes/No	Remarks
1.	Operator cabin should be fully covered and made by sound quality of material.	#		
2.	Carrier should be in good condition.	#		
3.	No damage in tire (Bolts, crack, cuts & air pressure, etc.).	#		
4.	Side mirror should be in good condition.	#		
5.	Head & tail light and indicators are in working condition.	#		
6.	Wiper should be in running condition.			
7.	Wind shield/glass should be in proper condition.	#		
8.	Seatbelt should be available.	#		
9.	Red triangle/reflective tape should be fixed in front of vehicle.			
10.	Hydraulic cylinder and hoses should be in good condition and free from leakage.	#		
11.	Registration number should be written.	#		
12.	Front & reverse horn.	#		
13.	Fire extinguisher in operator cabin.	#		
14.	Operator have valid and suitable license.	#		
15.	First aid kit should be available.			
16.	Normal break & emergency (hand) break should be in functional & operational condition.	#		

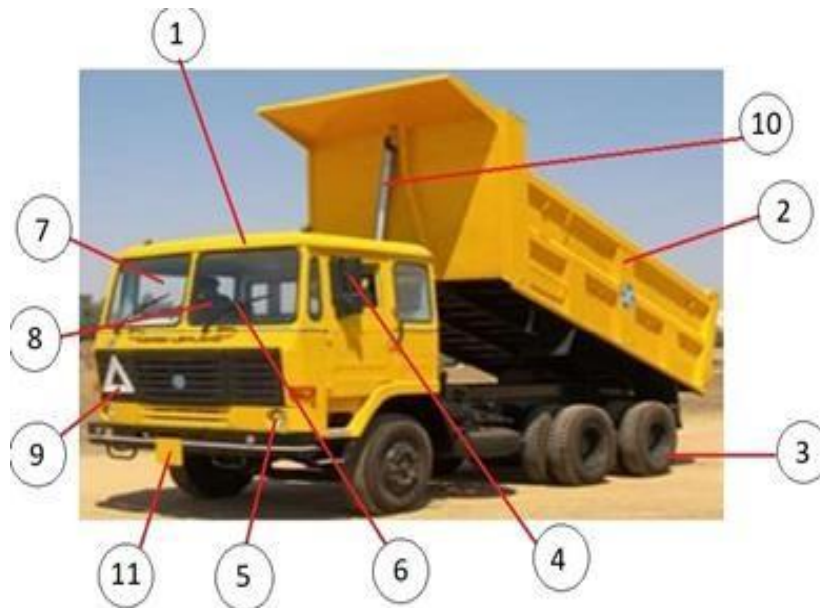

FIT <input type="checkbox"/>	PARTIALLY FIT <input type="checkbox"/>	UNFIT <input type="checkbox"/>
Inspected By		Reviewed By
Name:		Name:
Signature with date:		Signature with date:



ISGEC Heavy Engineering Limited

Checklist for Equipment Inspection

Project Name:

Project Code:

Checklist No.

Date:

Make:

Model:

ISGEC

Hired

Contractor

Equipment Name & Number:		4-EARTH COMPACTOR (ROLLER) &		
Note: Please write Yes or No in the given box and if some comments write in remarks column.				
SN.	Description		Yes/No	Remarks
1.	Earth compactor should be physically in good condition.	#		
2.	No damage in tire (Bolts, crack, cuts & air pressure, etc.).	#		
3.	No damage in compacting roller.			
4.	Dangerous and moving part should be covered with fix guard.	#		
5.	Head & tail light and indicators are in working condition.	#		
6.	Side mirror should be in good condition.	#		
7.	Wind shield/glass should be in proper condition.	#		
8.	Wiper should be in running condition.			
9.	Front & reverse horn.	#		
10.	Fire extinguisher in operator cabin.	#		
11.	Operator have valid and suitable license.	#		



FIT <input type="checkbox"/>	PARTIALLY FIT <input type="checkbox"/>	UNFIT <input type="checkbox"/>
Inspected By		Reviewed By
Name:		Name:
Signature with date:		Signature with date:



ISGEC Heavy Engineering Limited

Checklist for Equipment Inspection

Project Name:
Checklist No.
Make:
 ISGEC

Hired

Project Code:
Date:
Model:
 Contractor

Equipment Name & Number:		5-CONCRETE MIXER &		
Note: Please write Yes or No in the given box and if some comments write in remarks column.				
SN.	Description		Yes/No	Remarks
1.	Mixer machine should be physically fit.	#		
2.	Rotating part & IC engine should be covered with fix guard.	#		
3.	No damage in tire (crack, cuts & air pressure, etc.).	#		
4.	Rotating part of gear should be covered.	#		
5.	Proper handle lock should be available.	#		
6.	Handle should be free from defect.			
7.	Mixer machine should be with proper handle to control the movement.	#		
8.	Spark arrestor should be installed, if machine is operating in flammable atmosphere.			



FIT <input type="checkbox"/>	PARTIALLY FIT <input type="checkbox"/>	UNFIT <input type="checkbox"/>
Inspected By		Reviewed By
Name:		Name:
Signature with date:		Signature with date:



ISGEC Heavy Engineering Limited

Checklist for Equipment Inspection

Project Name:
Checklist No.
Make:
 ISGEC

Hired

Project Code:
Date:
Model:
 Contractor

Equipment Name & Number:	6-TRANSIT MIXER &		
Note: Please write Yes or No in the given box and if some comments write in remarks column.			
SN.	Description	Yes/No	Remarks
1.	Transit mixer should be physically in good condition.	#	
2.	No damage in tire (Bolts, crack, cuts & air pressure, etc.).	#	
3.	Registration number should be written.	#	
4.	Head & tail light and indicators are in working condition.	#	
5.	Side mirror should be in good condition.	#	
6.	Wind shield/glass should be in proper condition.	#	
7.	Wiper should be in running condition.		
8.	Red triangle/reflective tape should be fixed in front of vehicle.		
9.	Rotatory part of secondary engine should be covered with fix guard.	#	
10.	Rotating part of gear box should be covered by fixed guard.	#	
11.	Inbuilt ladder should be proper with suitable guard.	#	
12.	Front & reverse horn.	#	
13.	Fire extinguisher in operator cabin.	#	
14.	Operator have valid and suitable license.	#	
15.	First aid kit should be available.		
16.	Normal break & emergency (hand) break should be in functional & operational condition.	#	



FIT <input type="checkbox"/>	PARTIALLY FIT <input type="checkbox"/>	UNFIT <input type="checkbox"/>
Inspected By		Reviewed By
Name:		Name:
Signature with date:		Signature with date:



ISGEC Heavy Engineering Limited

Checklist for Equipment Inspection

Project Name:
Checklist No.
Make:
 ISGEC

Hired

Project Code:
Date:
Model:
 Contractor

Equipment Name & Number:		7-CONCRETE PUMP &		
Note: Please write Yes or No in the given box and if some comments write in remarks column.				
SN.	Description		Yes/No	Remarks
1.	Concrete pump should be physically in good condition.	#		
2.	No damage in tire (Bolts, crack, cuts & air pressure, etc.).	#		
3.	Outrigger should be free from damages.	#		
4.	Dangerous or moving part should be covered with fix guard.	#		
5.	Panel/switch board should be covered properly.			
6.	Emergency stop button should be mushroom headed with red colour.	#		
7.	Concrete hopper should be in good condition.			
8.	Suitable mesh should be kept on hopper to avoid getting in touch with moving part.	#		
9.	Clamp should be proper for tight joint of pipe.	#		
10.	Hook should have sufficient strength to carry self-load during shifting.			
11.	In case of electrically operated, electrical connection should be taken in proper manner.	#		
12.	In case of electrically operated, machine should be grounded as per IS 3043:1987.	#		
13.	Concrete pump should be operated by competent person.	#		
14.	Concrete pipe should be free from damages.	#		



FIT <input type="checkbox"/>	PARTIALLY FIT <input type="checkbox"/>	UNFIT <input type="checkbox"/>
Inspected By		Reviewed By
Name:		Name:
Signature with date:		Signature with date:



ISGEC Heavy Engineering Limited

Checklist for Equipment Inspection

Project Name:
Checklist No.
Make:
 ISGEC

Hired

Project Code:
Date:
Model:
Contractor

Equipment Name & Number:		8-BOOM PLACER &		
Note: Please write Yes or No in the given box and if some comments write in remarks column.				
SN.	Description		Yes/No	Remarks
1.	Boom placer should be physically good.	#		
2.	No damage in tire (Bolts, crack, cuts & air pressure, etc.).	#		
3.	Head & tail light and indicators are in working condition.	#		
4.	Outrigger should be free from damages.	#		
5.	Wind shield/glass should be in proper condition.	#		
6.	Wiper should be in running condition.			
7.	Side mirror should be in good condition.	#		
8.	Boom should be free from defects.	#		
9.	Hydraulic cylinder and hoses should be in good condition and free from leakage.	#		
10.	Pipe should be free from defects e.g. bend, crack, etc.	#		
11.	Red triangle/reflective tape should be fixed in front of vehicle.			
12.	Rotatory part of secondary engine should be covered with fix guard.	#		
13.	Front & reverse horn.	#		
14.	Fire extinguisher in operator cabin.	#		
15.	Operator have suitable license/experience certificate.	#		
16.	First aid kit should be available.			
17.	Normal break & emergency (hand) break should be in functional & operational condition.	#		
18.	Concrete hopper should be covered with mesh.	#		

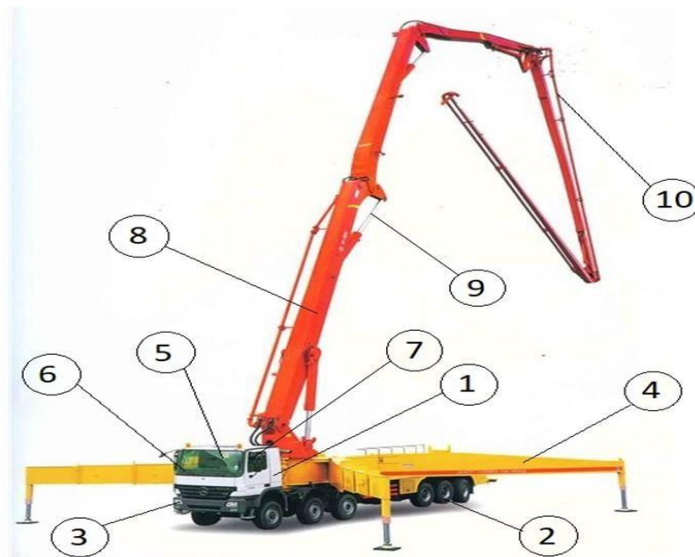

FIT <input type="checkbox"/>	PARTIALLY FIT <input type="checkbox"/>	UNFIT <input type="checkbox"/>
Inspected By		Reviewed By
Name:		Name:
Signature with date:		Signature with date:



ISGEC Heavy Engineering Limited

Checklist for Equipment Inspection

Project Name:
Checklist No.
Make:
 ISGEC

Hired

Project Code:
Date:
Model:
 Contractor

Equipment Name & Number:		9-ELECTRICAL VIBRATOR &		
Note: Please write Yes or No in the given box and if some comments write in remarks column.				
SN.	Description	#	Yes/No	Remarks
1.	Physical condition of body should be good & sound.	#		
2.	Power cable should be free from damages and connection taken through industrial plug.	#		
3.	Junction box of motor should be free from defects.	#		
4.	On/off switch should be properly insulated.	#		
5.	Rotating part of machine should be covered by fixed guard.	#		
6.	Needle should be tightly connected with motor.			
7.	Needle should be free from damages.			
8.	Machine should be grounded as per IS 3043:1987.	#		

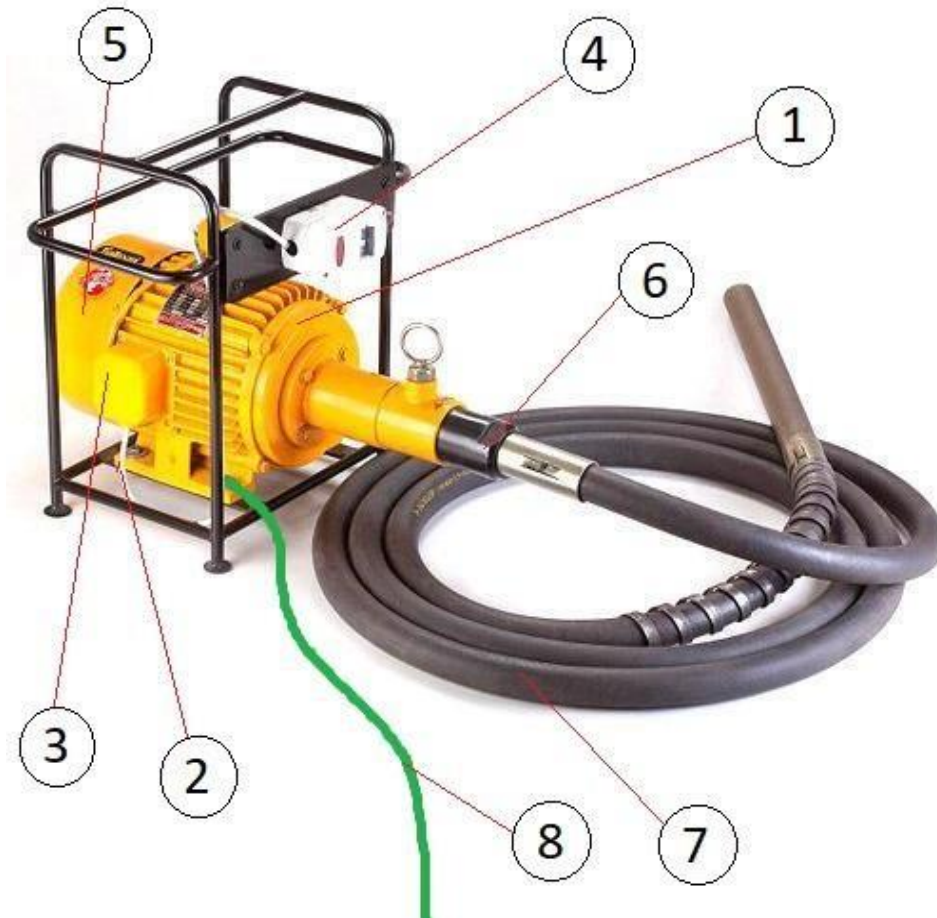

FIT <input type="checkbox"/>	PARTIALLY FIT <input type="checkbox"/>	UNFIT <input type="checkbox"/>
Inspected By		Reviewed By
Name:		Name:
Signature with date:		Signature with date:



ISGEC Heavy Engineering Limited

Checklist for Equipment Inspection

Project Name:
Checklist No.
Make:
 ISGEC

Project Code:
Date:
Model:
 Contractor

Hired

Equipment Name & Number:		10-BAR CUTTING MACHINE &		
Note: Please write Yes or No in the given box and if some comments write in remarks column.				
SN.	Description		Yes/No	Remarks
1.	Physical condition of body should be good & sound.	#		
2.	Junction box of motor should be full packed.	#		
3.	Rotating part of machine should be covered by fixed guard.	#		
4.	Operating lever should be insulated with nonconductive material.	#		
5.	Bar guard should be fixed with machine.	#		
6.	Machine should be grounded as per IS 3043:1987.	#		
7.	Power cable should be free from damages and connection taken through industrial plug.	#		
8.	Machine should be operated by competent person..	#		



FIT <input type="checkbox"/>	PARTIALLY FIT <input type="checkbox"/>	UNFIT <input type="checkbox"/>
Inspected By		Reviewed By
Name:		Name:
Signature with date:		Signature with date:



ISGEC Heavy Engineering Limited

Checklist for Equipment Inspection

Project Name:
Checklist No.
Make:
 ISGEC

Project Code:
Date:
Model:
 Contractor

Hired

Equipment Name & Number:		11-BAR BENDING MACHINE &		
Note: Please write Yes or No in the given box and if some comments write in remarks column.				
SN.	Description		Yes/No	Remarks
1.	Physical condition of body should be good & sound.	#		
2.	Electrical connection should be taken through industrial plug in proper manner.	#		
3.	Power cable should be free from damages.	#		
4.	Operating switch should be free from defects, e.g., uninsulated & broken, etc.	#		
5.	On/off or other switches should free from defects, e.g., uninsulated & broken, etc.	#		
6.	Emergency stop button should be mushroom headed with red colour.	#		
7.	Bar support should be properly fitted with machine.	#		
8.	Pins should be free from loose fitting.	#		
9.	Machine should be grounded as per IS 3043:1987.	#		
10.	Machine should be operated by competent person.	#		

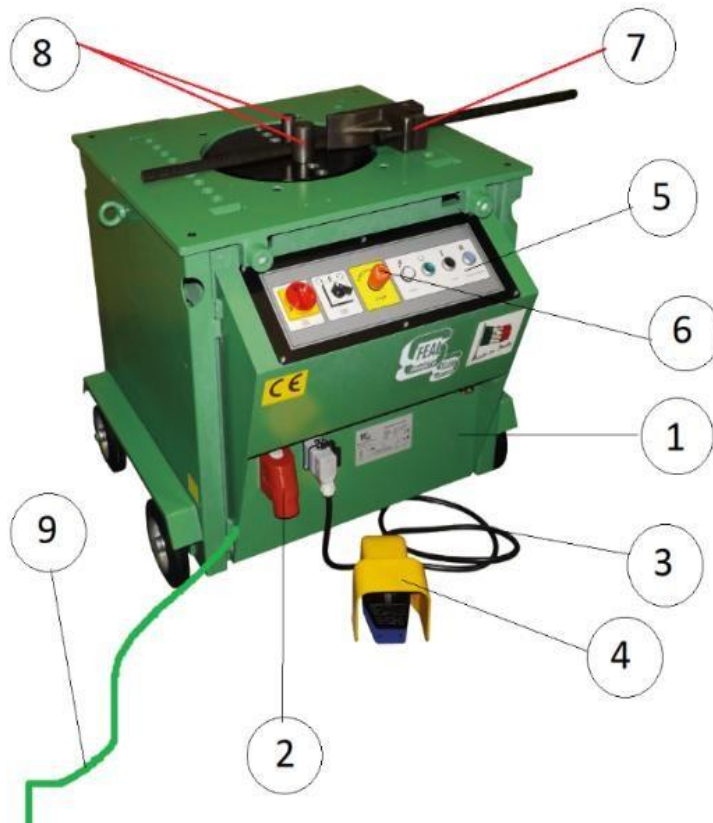

FIT <input type="checkbox"/>	PARTIALLY FIT <input type="checkbox"/>	UNFIT <input type="checkbox"/>
Inspected By	Reviewed By	
Name:	Name:	
Signature with date:	Signature with date:	



ISGEC Heavy Engineering Limited

Checklist for Equipment Inspection

Project Name:
Checklist No.
Make:
 ISGEC

Project Code:
Date:
Model:
 Contractor

Hired

Equipment Name & Number:		12-BREAKER &		
Note: Please write Yes or No in the given box and if some comments write in remarks column.				
SN.	Description		Yes/No	Remarks
1.	Breaker should be in good and working condition.	#		
2.	Power cable should be free from damages and connection taken through industrial plug.	#		
3.	A flexible cord should be provided to keep cable free from damage.			
4.	Handle should be provided for better control.			
5.	Bit should be in good condition and free from defect.			
6.	Breaker should be double insulated otherwise grounded.			
7.	Machine operated by competent person.	#		



FIT <input type="checkbox"/>	PARTIALLY FIT <input type="checkbox"/>	UNFIT <input type="checkbox"/>
Inspected By		Reviewed By
Name:		Name:
Signature with date:		Signature with date:



ISGEC Heavy Engineering Limited

Checklist for Equipment Inspection

Project Name:
Checklist No.
Make:
 ISGEC

Project Code:
Date:
Model:
 Contractor

Hired

Equipment Name & Number:		13-DRILL MACHINE &		
Note: Please write Yes or No in the given box and if some comments write in remarks column.				
SN.	Description	#	Yes/No	Remarks
1.	Drill machine should be in good and working condition.	#		
2.	Power cable should be free from damages and connection taken through industrial plug.	#		
3.	A flexible cord should be provided to keep cable free from damage.			
4.	Dead man switch should be in working condition.	#		
5.	Handle should be provided for better control.			
6.	Drill bit should be in good condition and free from defect.			
7.	Always use designated key for removing and changing drill bit.			
8.	Drill machine should be double insulated otherwise grounded.			
9.	Machine operated by competent person.	#		

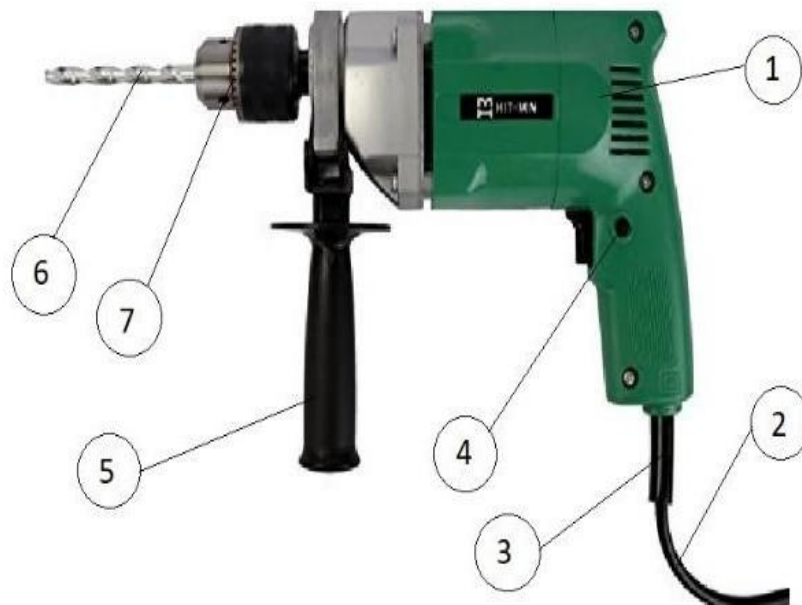

FIT <input type="checkbox"/>	PARTIALLY FIT <input type="checkbox"/>	UNFIT <input type="checkbox"/>
Inspected By		Reviewed By
Name:		Name:
Signature with date:		Signature with date:



ISGEC Heavy Engineering Limited

Checklist for Equipment Inspection

Project Name:
Checklist No.
Make:
 ISGEC

Hired

Project Code:
Date:
Model:
 Contractor

Equipment Name & Number:	14-HYDRA &		
Note: Please write Yes or No in the given box and if some comments write in remarks column.			
SN.	Description	Yes/No	Remarks
1.	Hydra should be physically good & certified by TPI.	#	
2.	No damage in tire (Bolts, crack, cuts & air pressure, etc.).	#	
3.	Registration number should be written.	#	
4.	Head & tail light and indicators are in working condition.	#	
5.	No oil leakage in hydraulic part.	#	
6.	Safe work load (SWL) marked.	#	
7.	Sling drum should be in good condition.	#	
8.	Boom condition while full extension (free from damage, crack & jamming, etc.).	#	
9.	Wire rope free from damage.	#	
10.	Hoist limit switch.	#	
11.	Safety latch in hook.	#	
12.	Safe load indicator should be in working condition.	#	
13.	Front & reverse horn.	#	
14.	Fire extinguisher in operator cabin.	#	
15.	Operator should have valid license (heavy duty).	#	
16.	Load chart available in operator cabin.		

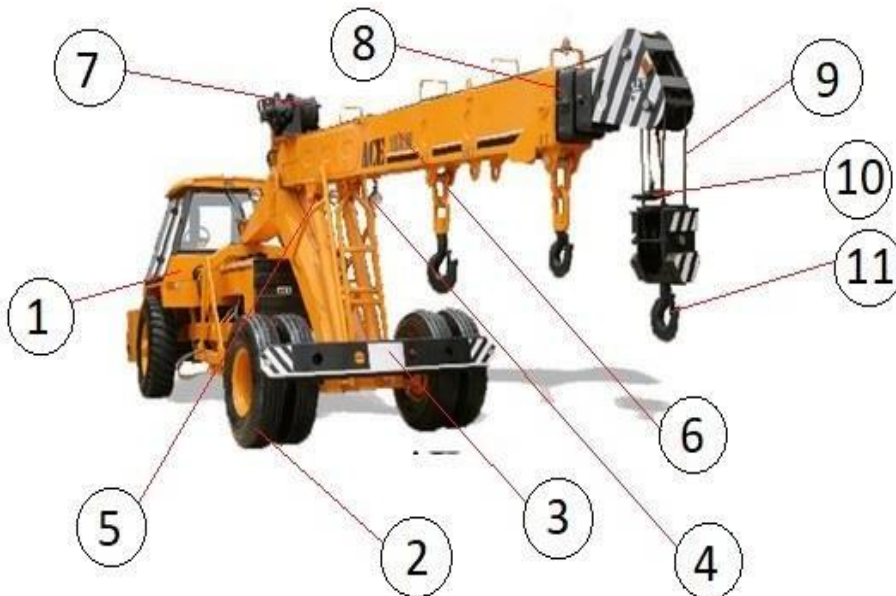

FIT <input type="checkbox"/>	PARTIALLY FIT <input type="checkbox"/>	UNFIT <input type="checkbox"/>
Inspected By		Reviewed By
Name:		Name:
Signature with date:		Signature with date:



ISGEC Heavy Engineering Limited

Checklist for Equipment Inspection

Project Name:
Checklist No.
Make:
 ISGEC

Project Code:
Date:
Model:
 Contractor

Hired

Equipment Name & Number:		15-MOBILE CRANE &		
Note: Please write Yes or No in the given box and if some comments write in remarks column.				
SN.	Description		Yes/No	Remarks
1.	Physical condition of body should be in sound manner.	#		
2.	No damage in tire (Bolts, crack, cuts & air pressure, etc.).	#		
3.	Head & tail light and indicators are in working condition.	#		
4.	Side mirror should be in good condition.	#		
5.	Safe work load (SWL) marked.	#		
6.	Hoist limit switch.	#		
7.	Wire rope free from damage.	#		
8.	Safety latch in hook.	#		
9.	Outrigger with spreader mat should be in good and working condition.	#		
10.	Sprit level should be installed.	#		
11.	Boom condition while full extension (free from damage, crack & jamming, etc.).	#		
12.	No oil leakage in hydraulic part.	#		
13.	Safe load indicator should be in working state.	#		
14.	Front, reverse and swing horn.	#		
15.	Fire extinguisher in operator cabin.	#		
16.	Operator should have valid and suitable license.	#		
17.	Crane simulator should be in working condition.	#		
18.	First aid kit should be available.			
19.	Crane should be physically good & should have valid TPI.	#		

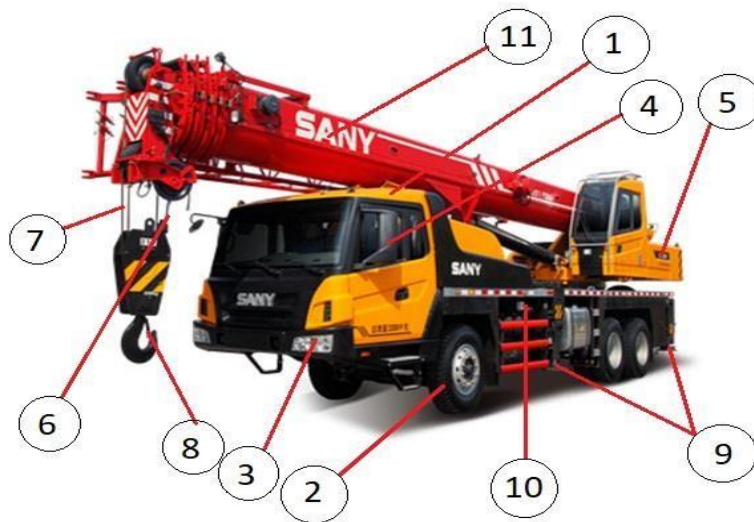

FIT <input type="checkbox"/>	PARTIALLY FIT <input type="checkbox"/>	UNFIT <input type="checkbox"/>
Inspected By		Reviewed By
Name:		Name:
Signature with date:		Signature with date:



ISGEC Heavy Engineering Limited

Checklist for Equipment Inspection

Project Name:
Checklist No.
Make:
 ISGEC

Project Code:
Date:
Model:
 Contractor

Hired

Equipment Name & Number:	16-TOWER CRANE &			
Note: Please write Yes or No in the given box and if some comments write in remarks column.				
SN.	Description	#	Yes/No	Remarks
1.	Tower crane should be physically in good condition, free from defects.	#		
2.	Foundation should be provided as per design.	#		
3.	Operator cabin should be in good condition, equipped with wind glasses and wireless communication.	#		
4.	Safe working load should be marked.	#		
5.	Counter weight should be properly fixed.	#		
6.	Hydraulic cylinder, hoses should be in good condition and free from leakage.	#		
7.	Trolley condition should be good.	#		
8.	Over hoist limit switch should be in working state.	#		
9.	Limit switch should be provided for trolley motor.	#		
10.	Sling should be free from defects.	#		
11.	Safety latch should be in hook.	#		
12.	Power cable should be free from damages and connection taken through industrial plug.	#		
13.	Tower crane should be grounded as per IS 3043:1987.	#		
14.	Safe load indicator should be in working condition.	#		
15.	Fire extinguisher in operator cabin.			
16.	Operator have suitable license/experience certificate.	#		
17.	First aid kit should be available.			
18.	Tower crane should be physically good & should have valid TPI.	#		
19.	Anemometer should be in working condition.			

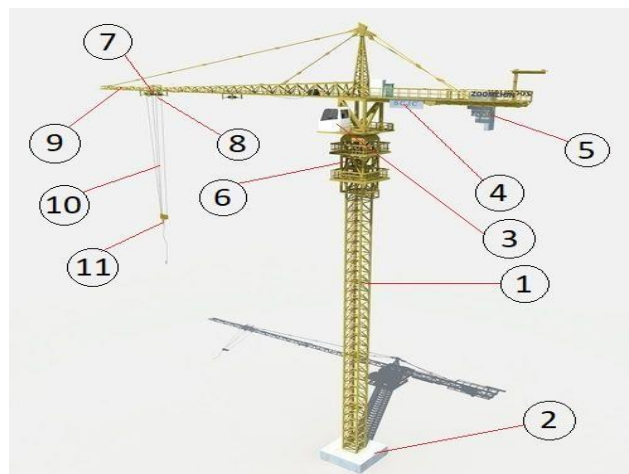

FIT <input type="checkbox"/>	PARTIALLY FIT <input type="checkbox"/>	UNFIT <input type="checkbox"/>
Inspected By		Reviewed By
Name:		Name:
Signature with date:		Signature with date:



ISGEC Heavy Engineering Limited

Checklist for Equipment Inspection

Project Name:
Checklist No.
Make:
 ISGEC

Project Code:
Date:
Model:
 Contractor

Hired

Equipment Name & Number:		17-DIESEL GENERATOR &		
Note: Please write Yes or No in the given box and if some comments write in remarks column.				
SN.	Description		Yes/No	Remarks
1.	Physical condition of DG should be good.	#		
2.	Door of DG should be in good condition, so that rotatory part of machine could cover.	#		
3.	Display panel should be in good condition.			
4.	Emergency stop button should be mushroom headed with red colour.	#		
5.	DG should be grounded as per IS 3043:1987.	#		
6.	Power supply panel provided with ELCB/RCCB/MCB.	#		
7.	Spark arrestor should be installed, if DG is operating in flammable atmosphere.			
8.	Diesel tank should free from leakage.	#		
9.	DG should be keep on aggregate/gravel stone.			
10.	Keep CO ₂ , BCP fire extinguisher/sand bucket near DG.	#		
11.	Fitness and pollution certificate should be taken from competent authority.			
12.	DG operated by competent person.	#		
13.	Spill observant kit or drip tray available.			
14.	Insulated rubber mat available.	#`		



FIT <input type="checkbox"/>	PARTIALLY FIT <input type="checkbox"/>	UNFIT <input type="checkbox"/>
Inspected By	Reviewed By	
Name:	Name:	
Signature with date:	Signature with date:	



ISGEC Heavy Engineering Limited

Checklist for Equipment Inspection

Project Name:
Checklist No.
Make:
 ISGEC

Hired

Project Code:
Date:
Model:
 Contractor

Equipment Name & Number:		18-POWER/SUB DISTRIBUTION PANEL &		
Note: Please write Yes or No in the given box and if some comments write in remarks column.				
SN.	Description		Yes/No	Remarks
1.	Physical condition of panel should be good & sound.	#		
2.	Panel should be kept on suitable stand.	#		
3.	Junction boxes should be free from defects.	#		
4.	All connection should be taken through ELCB/RCCB/MCB.	#		
5.	Connection socket should be covered with auto lock.			
6.	Switches and display should be properly covered.			
7.	A danger signage should be marked.			
8.	Panel should be grounded as per IS 3043:1987.	#		
9.	Further connection for extension of cable should be taken through male-female connector.	#		
10.	In case of flammable atmosphere single length cable shall be use.			
11.	Canopy should be provided to avoid water getting entered due to rain or any other means.	#		
12.	Rubber mat should be provided to stand during operation.	#		
13.	Input power cable should be free from defects.			
14.	Power input and output cable should be passes through glands.	#		

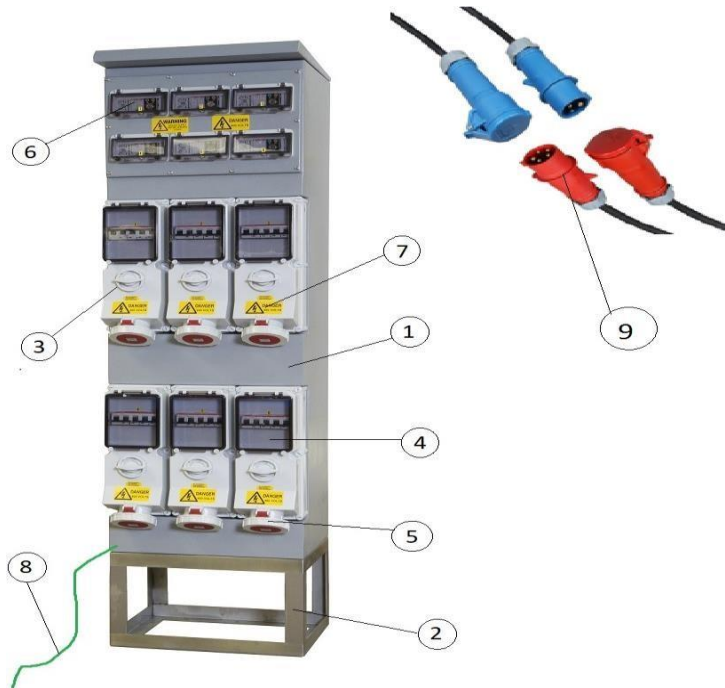

FIT <input type="checkbox"/>	PARTIALLY FIT <input type="checkbox"/>	UNFIT <input type="checkbox"/>
Inspected By		Reviewed By
Name:		Name:
Signature with date:		Signature with date:



ISGEC Heavy Engineering Limited

Checklist for Equipment Inspection

Project Name:
Checklist No.
Make:
 ISGEC

Project Code:
Date:
Model:
 Contractor

Hired

Equipment Name & Number:		19-GAS CUTTING SET &		
Note: Please write Yes or No in the given box and if some comments write in remarks column.				
SN.	Description	#	Yes/No	Remarks
1.	Cylinder should be kept in trolley.	#		
2.	Always keep in upright position.	#		
3.	Properly secured.	#		
4.	Valve protection cap.	#		
5.	Regulator should be free from any defect.	#		
6.	Pressure gauge should be in proper condition.	#		
7.	Provide flash back arrestor.	#		
8.	Provide industrial clip.			
9.	Hose condition should be good with colour coded.	#		
10.	Joint should be firm and free from defect, e.g., oily, rust & leakage, etc.	#		
11.	Torch should be in good condition.	#		
12.	Use proper PPEs for the Job, e.g., Leather hand gloves & safety goggles, etc.	#		
13.	Keep fire extinguisher at working place.	#		
14.	Provide booth, made by fire retardant material (if required).			
15.	Work carried out by competent person.	#		

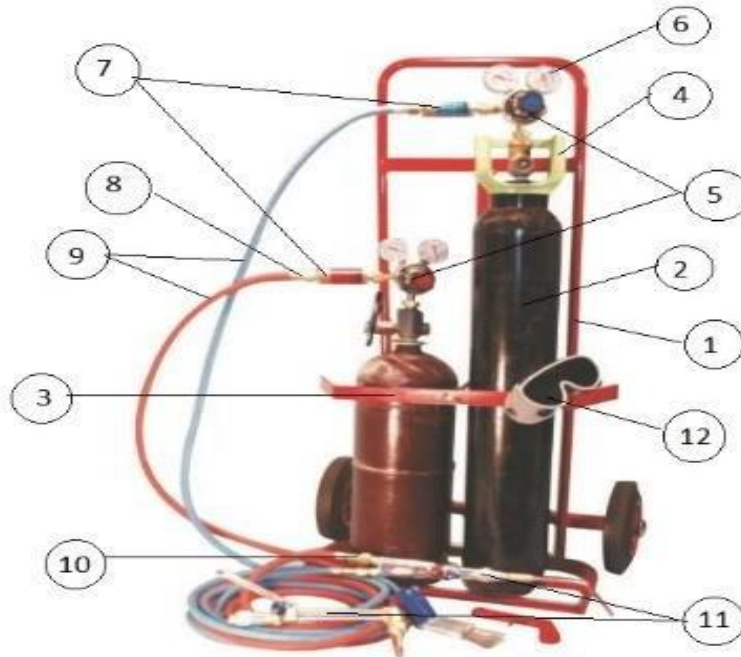

FIT <input type="checkbox"/>	PARTIALLY FIT <input type="checkbox"/>	UNFIT <input type="checkbox"/>
Inspected By		Reviewed By
Name:		Name:
Signature with date:		Signature with date:



ISGEC Heavy Engineering Limited

Checklist for Equipment Inspection

Project Name:
Checklist No.
Make:
 ISGEC

Hired

Project Code:
Date:
Model:
 Contractor

Equipment Name & Number:		20-PORTABLE GRINDER &		
Note: Please write Yes or No in the given box and if some comments write in remarks column.				
SN.	Description		Yes/No	Remarks
1.	Grinding machine should be in good and working condition.	#		
2.	Power cable should be free from damages and connection taken through industrial plug.	#		
3.	A flexible cord should be provided to keep cable free from damage.			
4.	Motor capacity should be marked in RPM.			
5.	Dead man switch should be in working condition.	#		
6.	Handle should be provided for better control.			
7.	Wheel guard should be properly installed with machine, so that gap between guard and wheel should not be more than 3mm.	#		
8.	Grinding/cutting wheel should free from defect and rotating capacity should be marked.	#		
9.	Grinding machine should be double insulated otherwise grounded.			
10.	Always use designated key for removing and changing wheel.			
11.	Machine operated by competent person.	#		
12.	RPM of wheel should be more than RPM of motor.	#		



FIT <input type="checkbox"/>	PARTIALLY FIT <input type="checkbox"/>	UNFIT <input type="checkbox"/>
Inspected By		Reviewed By
Name:		Name:
Signature with date:		Signature with date:



ISGEC Heavy Engineering Limited

Checklist for Equipment Inspection

Project Name:
Checklist No.
Make:
 ISGEC

Hired

Project Code:
Date:
Model:
 Contractor

Equipment Name & Number:		21-WELDING MACHINE &		
Note: Please write Yes or No in the given box and if some comments write in remarks column.				
SN.	Description	#	Yes/No	Remarks
1.	Welding machine should be in good and working condition.	#		
2.	Power cable should be free from damages and connection taken through industrial plug and .	#		
3.	Switches should be free from defects, e.g., uninsulated & damages, etc.	#		
4.	Welding led & return led connection should be tightly by means of lugs/socket.	#		
5.	Welding led & return led should be free from damages, e.g., cuts, naked, too many joint, etc.	#		
6.	Welding holder should be in good condition and free from metal contact.	#		
7.	Earthing holder should be in good condition and free from rust.	#		
8.	Welding machine should be grounded as per IS 3043:1987.	#		
9.	Keep fire extinguisher at working place.	#		
10.	Provide booth, made by fire retardant material (if required).			
11.	Work carried out by competent person.	#		



FIT <input type="checkbox"/>	PARTIALLY FIT <input type="checkbox"/>	UNFIT <input type="checkbox"/>
Inspected By	Reviewed By	
Name:	Name:	
Signature with date:	Signature with date:	



ISGEC Heavy Engineering Limited

Checklist for Equipment Inspection

Project Name:
Checklist No.
Make:
 ISGEC

Project Code:
Date:
Model:
 Contractor

Hired

Equipment Name & Number:		22-ELECTRICAL PUMP/MOTOR &		
Note: Please write Yes or No in the given box and if some comments write in remarks column.				
SN.	Description		Yes/No	Remarks
1.	Physical condition of pump should be good.	#		
2.	Power cable should be free from damages and connection taken through industrial plug.	#		
3.	Cable entry point should be fully packed, so that water can't enter.	#		
4.	Junction box of motor should be free from defects.	#		
5.	On/off switch should be properly insulated.	#		
6.	Rotating part of machine should be covered by fixed guard.	#		
7.	Machine should be grounded as per IS 3043:1987.	#		

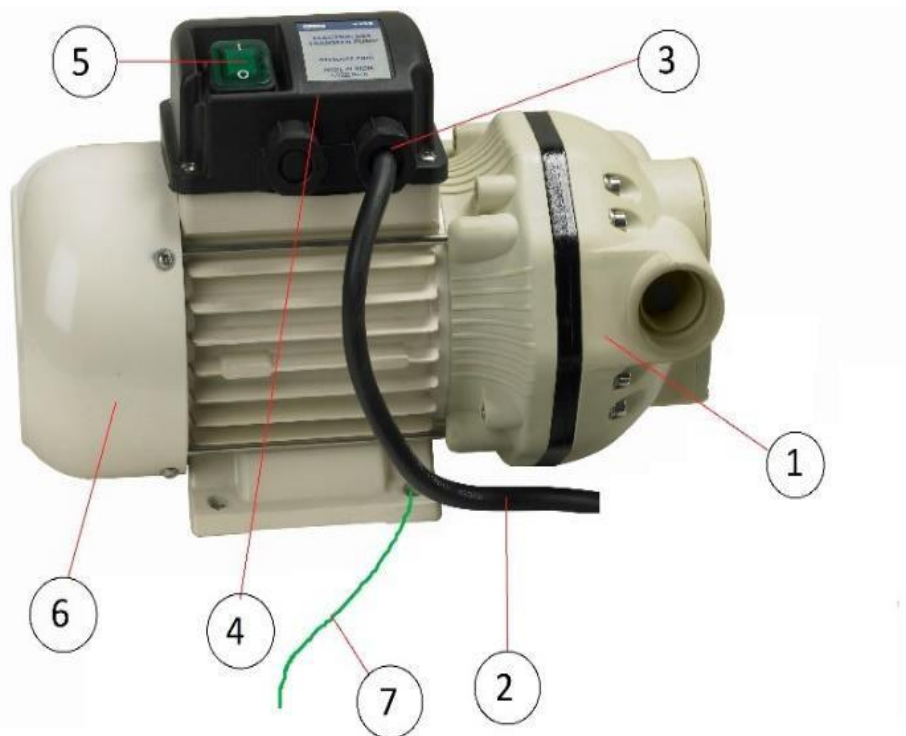

FIT <input type="checkbox"/>	PARTIALLY FIT <input type="checkbox"/>	UNFIT <input type="checkbox"/>
Inspected By	Reviewed By	
Name:	Name:	
Signature with date:	Signature with date:	



ISGEC Heavy Engineering Limited

Checklist for Equipment Inspection

Project Name:
Checklist No.
Make:
 ISGEC

Hired

Project Code:
Date:
Model:
 Contractor

Equipment Name & Number:		23-WINCH MACHINE &		
Note: Please write Yes or No in the given box and if some comments write in remarks column.				
SN.	Description		Yes/No	Remarks
1.	Winch should be in good and working condition and certified by TPI.	#		
2.	Rotating part should be covered with fixed guard.	#		
3.	Operating liver should be free from defects.	#		
4.	Rope drum should have sufficient space to roll-in full slings.	#		
5.	Wire sling should be free from damages.	#		
6.	Sling should be knotted in proper manner.	#		
7.	Safety latch should be in hook.	#		
8.	Winch should be grounded as per IS 3043:1987.	#		
9.	Winch machine should be properly fixed with hard structure.	#		
10.	Power cable should be free from damages and connection taken through industrial plug.	#		
11.	SWL should be written.	#		

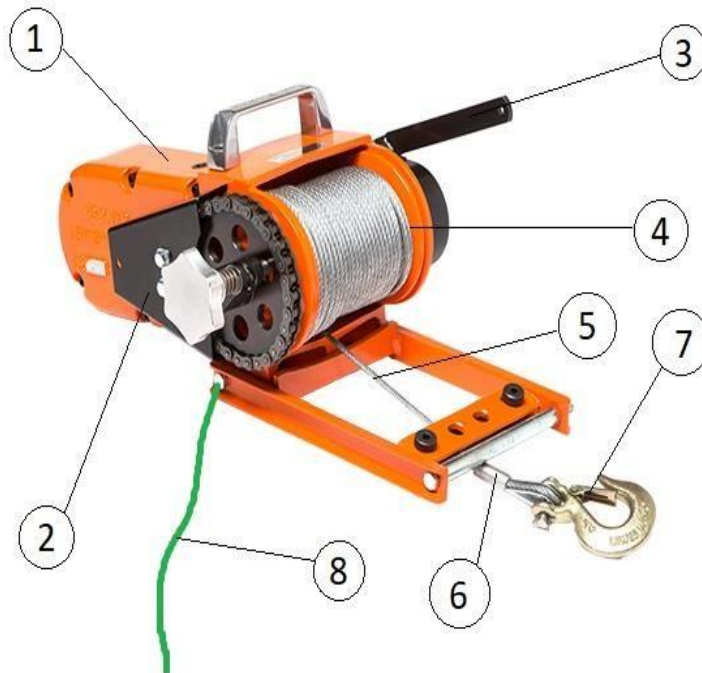

FIT <input type="checkbox"/>	PARTIALLY FIT <input type="checkbox"/>	UNFIT <input type="checkbox"/>
Inspected By		Reviewed By
Name:		Name:
Signature with date:		Signature with date:



ISGEC Heavy Engineering Limited

Checklist for Equipment Inspection

Project Name:
Checklist No.
Make:
 ISGEC

Hired

Project Code:
Date:
Model:
 Contractor

Equipment Name & Number:		24-CHAIN PULLEY BLOCK &		
Note: Please write Yes or No in the given box and if some comments write in remarks column.				
SN.	Description	#	Yes/No	Remarks
1.	Chain pulley block should be in good and working condition and certified by TPI.	#		
2.	Chain should be free from defects, e.g., crack, corrosion, etc.	#		
3.	Hook should be in good condition, not stretched more than 15% of its original shape.	#		
4.	Safety latch should be in hook.	#		
5.	Safe working load should be marked and visible.	#		
6.	Rotating part should be covered.	#		

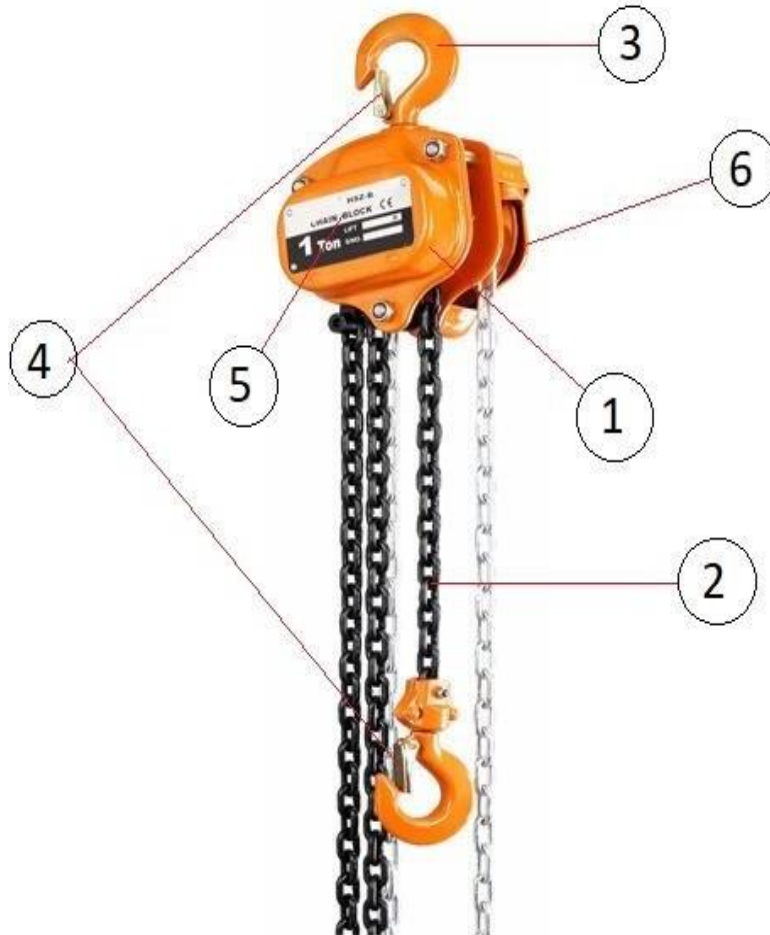

FIT <input type="checkbox"/>	PARTIALLY FIT <input type="checkbox"/>	UNFIT <input type="checkbox"/>
Inspected By		Reviewed By
Name:		Name:
Signature with date:		Signature with date:



ISGEC Heavy Engineering Limited

Checklist for Equipment Inspection

Project Name:
Checklist No.
Make:
 ISGEC

Project Code:
Date:
Model:
 Contractor

Hired

Equipment Name & Number:		25-LIFTING TOOLS & TACKLES &		
Note: Please write Yes or No in the given box and if some comments write in remarks column.				
SN.	Description		Yes/No	Remarks
1.	Wire sling should be free from defects, e.g., corrosion, crack, cuts & oily, etc.	#		
2.	Use thimble for making I-shape.			
3.	Wire rope should be knotted with proper clamp.	#		
4.	Web sling should be free from defects, e.g., cuts, abrasion, knot, hole & oily, etc.	#		
5.	I-shape should be free from damages.	#		
6.	D-shackle should be in good condition and its face should not expand more than 15% of its original shape.	#		
7.	Suitable I-bolt should be used.	#		
8.	Lifting tools & tackles should be used having suitable strength & capacity.	#		
9.	Lifting tools & tackles should be handle and store in safe manner.	#		



FIT <input type="checkbox"/>	PARTIALLY FIT <input type="checkbox"/>	UNFIT <input type="checkbox"/>
Inspected By	Reviewed By	
Name:	Name:	
Signature with date:	Signature with date:	



ISGEC Heavy Engineering Limited

Checklist for Equipment Inspection

Project Name:
Checklist No.
Make:
 ISGEC

Project Code:
Date:
Model:
 Contractor

Hired

Equipment Name & Number:		26-AIR COMPRESSOR &		
Note: Please write Yes or No in the given box and if some comments write in remarks column.				
SN.	Description		Yes/No	Remarks
1.	Physical condition of compressor tank should be good and certified by TPI.	#		
2.	Piston should be in good condition.	#		
3.	Motor should be in good and working condition.	#		
4.	Inspection date and due date should be clearly marked.	#		
5.	Pressure gauge should be in working state and free from defects.	#		
6.	Safety valve should be calibrated at regular interval.	#		
7.	Any other valve should be free from defects and in working condition.	#		
8.	Rotating part should be covered with fixed guard.	#		
9.	All joints should be properly tighten.	#		
10.	Compressor should be grounded as per IS 3043:1987.	#		
11.	Power cable should be free from defects and connection taken through industrial plug.	#		
12.	Whip arrestor is in good condition.	#		

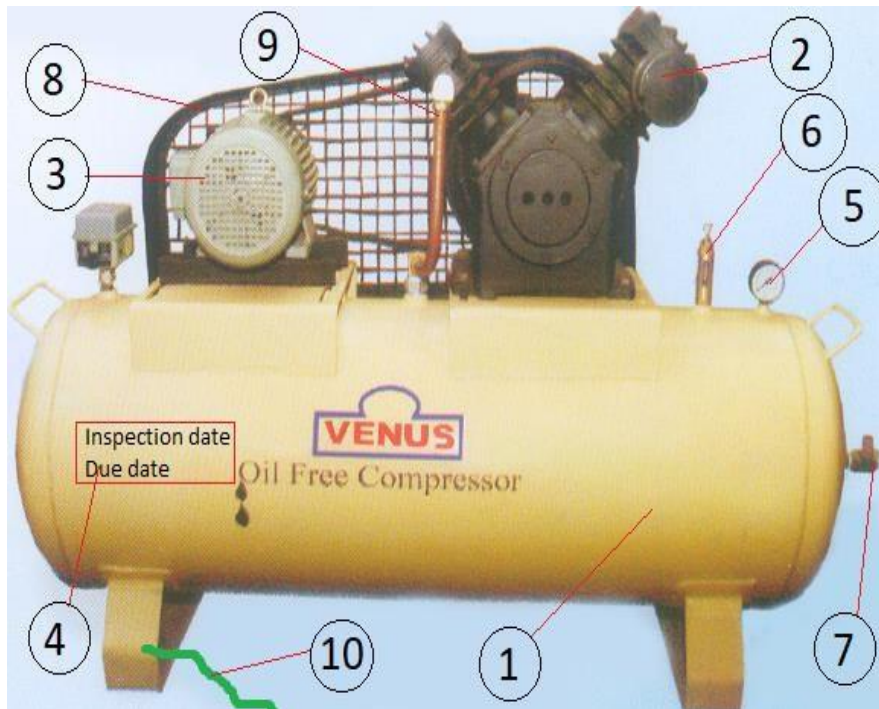

FIT <input type="checkbox"/>	PARTIALLY FIT <input type="checkbox"/>	UNFIT <input type="checkbox"/>
Inspected By		Reviewed By
Name:		Name:
Signature with date:		Signature with date:



ISGEC Heavy Engineering Limited

Checklist for Equipment Inspection

Project Name:
Checklist No.
Make:
 ISGEC

Hired

Project Code:
Date:
Model:
 Contractor

Equipment Name & Number:		27-GRIT/SAND BLASTING SET &		
Note: Please write Yes or No in the given box and if some comments write in remarks column.				
SN.	Description	#	Yes/No	Remarks
1.	Hopper is made by sound quality of material.	#		
2.	Pressure gauge in working condition.	#		
3.	All joints should be properly tighten and free from corrosion.	#		
4.	Inlet and outlet valve should be functional.	#		
5.	Blasting hose should have adequate strength and free from cuts or damages.	#		
6.	Nozzle should be in good condition with dead man switch.	#		
7.	Blasting hood must be provided for blaster with physical particle filtration.	#		
8.	Whip arrestor is in good condition.	#		

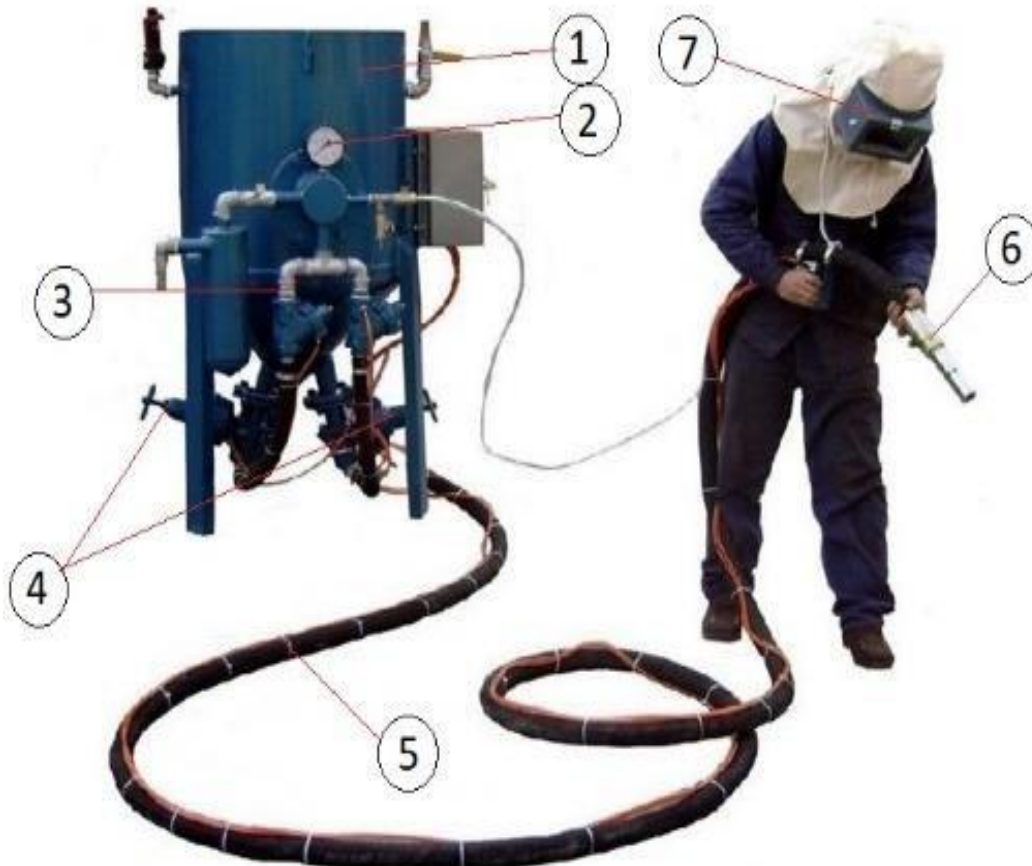

FIT <input type="checkbox"/>	PARTIALLY FIT <input type="checkbox"/>	UNFIT <input type="checkbox"/>
Inspected By	Reviewed By	
Name:	Name:	
Signature with date:	Signature with date:	



ISGEC Heavy Engineering Limited

Checklist for Equipment Inspection

Project Name:
Checklist No.
Make:
 ISGEC

Project Code:
Date:
Model:
 Contractor

Hired

Equipment Name & Number:		28-FIRE EXTINGUISHER &		
Note: Please write Yes or No in the given box and if some comments write in remarks column.				
SN.	Description		Yes/No	Remarks
1.	Fire extinguisher always keep on trolley, it will be easy for movement.			
2.	Keep Sand bucket.	#		
3.	Sand bucket should be covered to avoid mixing of foreign material.			
4.	Fire extinguisher should be kept at waist level height for quick access.			
5.	Fire extinguisher should be free from defects and regularly tested.	#		
6.	Inspection date and due date should be clearly marked.	#		
7.	Hose and hose connection are in good condition.	#		
8.	Check pressure gauge at regular interval for any pressure drop.	#		

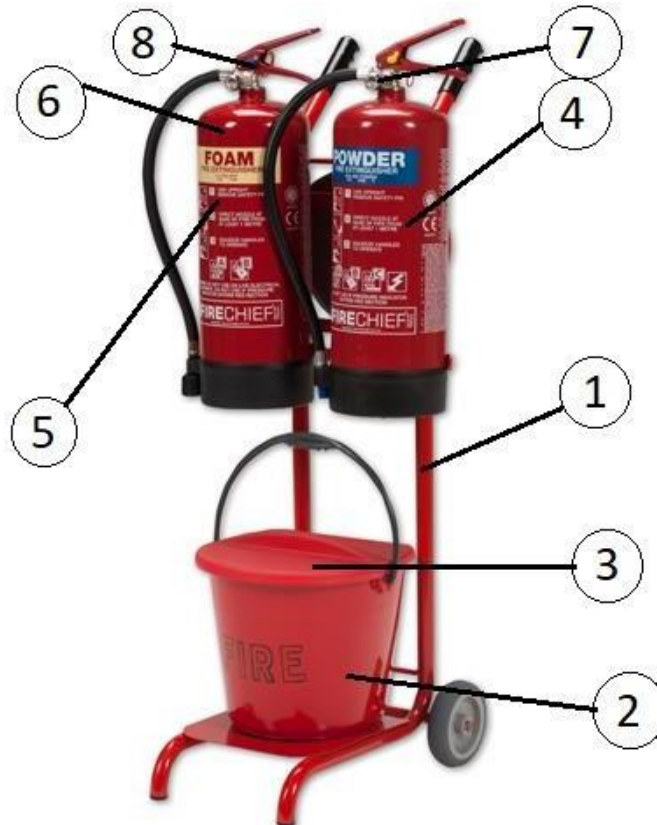

FIT <input type="checkbox"/>	PARTIALLY FIT <input type="checkbox"/>	UNFIT <input type="checkbox"/>
Inspected By		Reviewed By
Name:		Name:
Signature with date:		Signature with date:



ISGEC Heavy Engineering Limited

Checklist for Equipment Inspection

Project Name:
Checklist No.
Make:
 ISGEC

Project Code:
Date:
Model:
 Contractor

Hired

Equipment Name & Number:		29-BENCH CUTTING MACHINE &		
Note: Please write Yes or No in the given box and if some comments write in remarks column.				
SN.	Description		Yes/No	Remarks
1.	Physical condition of body should be good & sound.	#		
2.	On/off switch should be in proper condition.	#		
3.	Fixed guard should be in good condition.	#		
4.	Auto adjustable guard should be in functional condition.	#		
5.	Cutting wheel should be free from defect and rotating capacity should be marked, standard quality of cutting wheel used.	#		
6.	Positioning screw should be in working condition.	#		
7.	Power cable should be free from damage and connection taken through industrial plug.	#		
8.	Machine should be double insulated or grounded.	#		
9.	Always use designated key for changing wheel.			
10.	Machine operated by competent person.			



FIT <input type="checkbox"/>	PARTIALLY FIT <input type="checkbox"/>	UNFIT <input type="checkbox"/>
Inspected By		Reviewed By
Name:		Name:
Signature with date:		Signature with date:



ISGEC Heavy Engineering Limited

Checklist for Equipment Inspection

Project Name:
Checklist No.
Make:
 ISGEC

Hired

Project Code:
Date:
Model:
 Contractor

Equipment Name & Number:		30-PEDESTAL GRINDER &		
Note: Please write Yes or No in the given box and if some comments write in remarks column.				
SN.	Description		Yes/No	Remarks
1.	Physical condition of body should be good & sound.	#		
2.	On/off switch should be in proper condition.	#		
3.	Wheel guard should be in good condition.	#		
4.	Tool rest should be available at distance of 3 mm from rotating wheel.	#		
5.	Eye guard and spark deflector should be available.	#		
6.	Machine should be double insulated or grounded.	#		
7.	Wheel should free from defect and rotating capacity should be marked.	#		
8.	Power cable should be free from damage and connection taken through industrial plug.	#		
9.	Always use designated key for changing wheel.			
10.	Machine operated by competent person.			

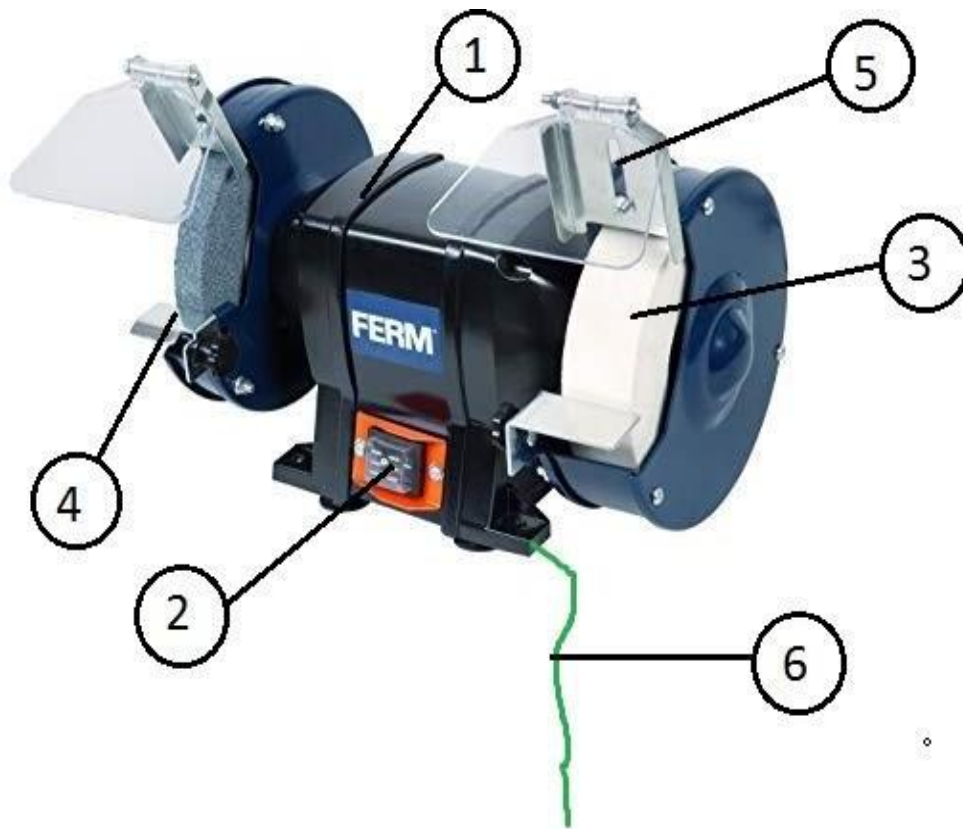

FIT <input type="checkbox"/>	PARTIALLY FIT <input type="checkbox"/>	UNFIT <input type="checkbox"/>
Inspected By		Reviewed By
Name:		Name:
Signature with date:		Signature with date:



ISGEC Heavy Engineering Limited

Checklist for Equipment Inspection

Project Name:
Checklist No.
Make:
 ISGEC

Project Code:
Date:
Model:
 Contractor

Hired

Equipment Name & Number:		31-CIRCULAR SAW &		
Note: Please write Yes or No in the given box and if some comments write in remarks column.				
SN.	Description		Yes/No	Remarks
1.	Physical condition of body should be good & sound.	#		
2.	On/off switch should be in proper condition.	#		
3.	Fixed guard should be in good condition.	#		
4.	Auto adjustable guard should be functional condition.	#		
5.	Wheel should free from defect and rotating capacity should be marked.	#		
6.	Power cable should be free from damage and connection taken through industrial plug.	#		
7.	Machine should be double insulated or grounded.	#		
8.	Always use designated key for changing wheel.			
9.	Machine operated by competent person.			



FIT <input type="checkbox"/>	PARTIALLY FIT <input type="checkbox"/>	UNFIT <input type="checkbox"/>
Inspected By		Reviewed By
Name:		Name:
Signature with date:		Signature with date:



ISGEC Heavy Engineering Limited

Checklist for Equipment Inspection

Project Name:
Checklist No.
Make:
 ISGEC

Project Code:
Date:
Model:
 Contractor

Hired

Equipment Name & Number:		32-BATCHING PLANT &		
Note: Please write Yes or No in the given box and if some comments write in remarks column.				
SN.	Description	#	Yes/No	Remarks
1.	Physical condition of body should be good & sound.	#		
2.	Staircase should be in good condition.	#		
3.	Operator cabin should be free from dust accumulation.	#		
4.	Metal mesh should be provided on the aggregate and sand hopper.	#		
5.	Conveyor belt should be guarded, covered and pull cord should be installed.	#		
6.	Mixing chamber should be closed.	#		
7.	Monkey ladder with cage should be available.	#		
8.	Guardrail system should be in good condition.	#		
9.	Lightening arrestor should be installed.	#		
10.	All part of machine should be grounded.	#		
11.	Power cable should be free from defect and connection taken through MCB and RCCB.	#		
12.	Fire extinguisher in operator cabin.	#		
13.	Operated by only authorized operator.	#		
14.	Emergency switch should be in working condition.	#		
15.	Aviation light should be in working condition.			
16.	Hooter is in working condition.			

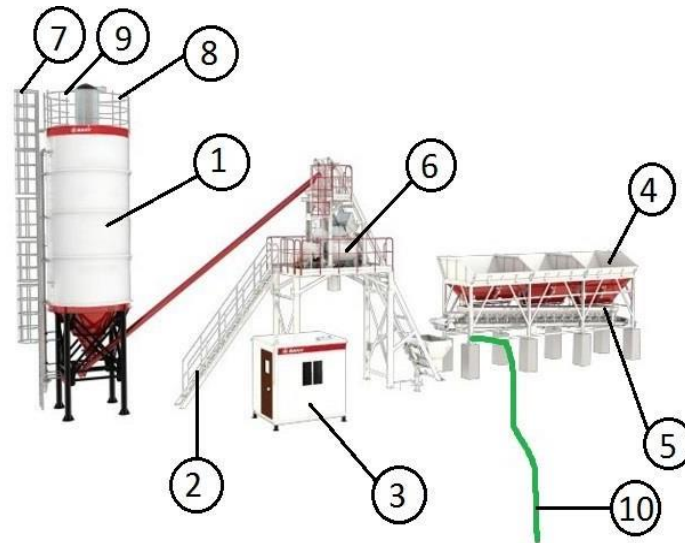

FIT <input type="checkbox"/>	PARTIALLY FIT <input type="checkbox"/>	UNFIT <input type="checkbox"/>
Inspected By	Reviewed By	
Name:	Name:	
Signature with date:	Signature with date:	



ISGEC Heavy Engineering Limited

Checklist for Equipment Inspection

Project Name:
Checklist No.
Make:
 ISGEC

Project Code:
Date:
Model:
 Contractor

Hired

Equipment Name & Number:		33-AMBULANCE &		
Note: Please write Yes or No in the given box and if some comments write in remarks column.				
SN.	Description	#	Yes/No	Remarks
1.	Physical condition of vehicle including brake and clutch.	#		
2.	Condition of tire and availability of spare/stepney tire.	#		
3.	Head & tail light and indicators are in working condition.	#		
4.	Side mirror.	#		
5.	Functional condition of emergency light and audible siren are in working condition.	#		
6.	Emergency contact number displayed.	#		
7.	Availability and condition of stretcher.	#		
8.	Availability of first aid kit with suitable medicine.	#		
9.	Portable fire extinguisher.	#		
10.	Medical oxygen cylinder with pressure gauge and availability of key to open the cylinder.	#		
11.	Condition of canister mask.	#		
12.	Availability and condition of fan for ventilation.	#		
13.	Driver has valid license for operating ambulance.	#		

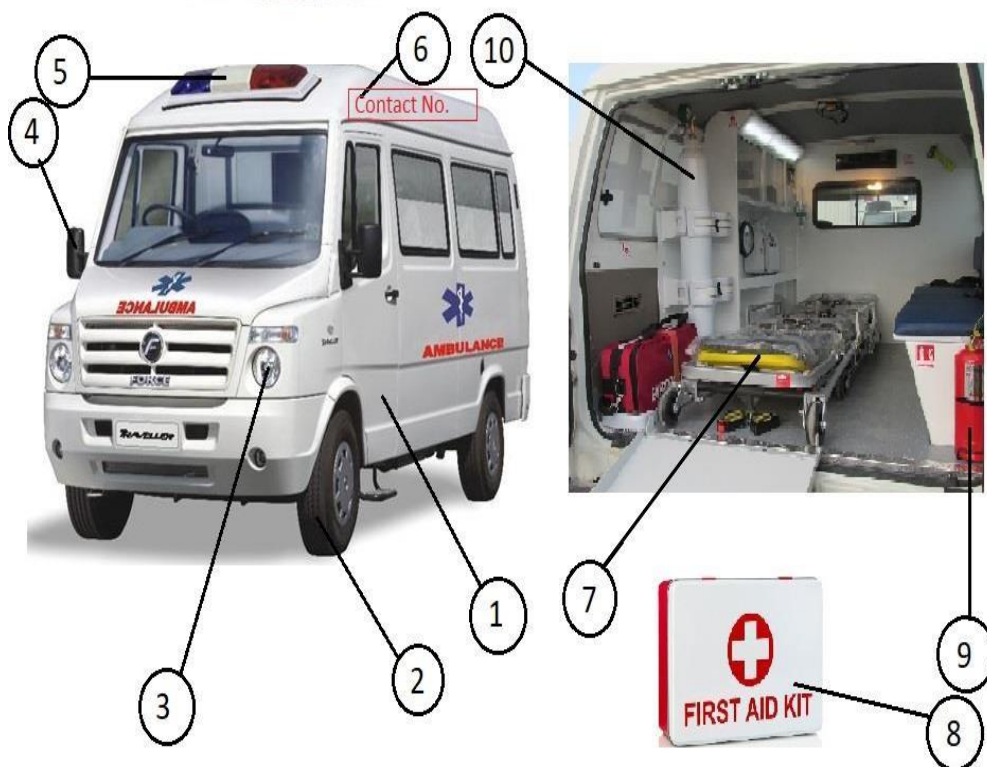

FIT <input type="checkbox"/>	PARTIALLY FIT <input type="checkbox"/>	UNFIT <input type="checkbox"/>
Inspected By		Reviewed By
Name:		Name:
Signature with date:		Signature with date:



ISGEC Heavy Engineering Limited

Checklist for Equipment Inspection

Project Name:
Checklist No.
Make:
 ISGEC

Project Code:
Date:
Model:
 Contractor

Hired

Equipment Name & Number:		34-SKID STEER LOADER &		
Note: Please write Yes or No in the given box and if some comments write in remarks column.				
SN.	Description		Yes/No	Remarks
1.	Machine should be physically good & should have valid TPI certificate.	#		
2.	No damage in tire (Bolts, crack, cuts & air pressure, etc.).	#		
3.	Head & tail light and indicators are in working condition.	#		
4.	Side mirror should be in good condition.	#		
5.	Wind shield/glass should be in proper condition.	#		
6.	Wiper should be in running condition.			
7.	Operator cabin should be made by good & sound quality of material.	#		
8.	Hydraulic cylinders should be in good condition and free from leakage.	#		
9.	Foot Step should be free from slip or tip hazard.			
10.	Red triangle/reflective tape should be fixed in front of vehicle.			
11.	Front & reverse horn.	#		
12.	Fire extinguisher in operator cabin.	#		
13.	Operator have suitable license.	#		

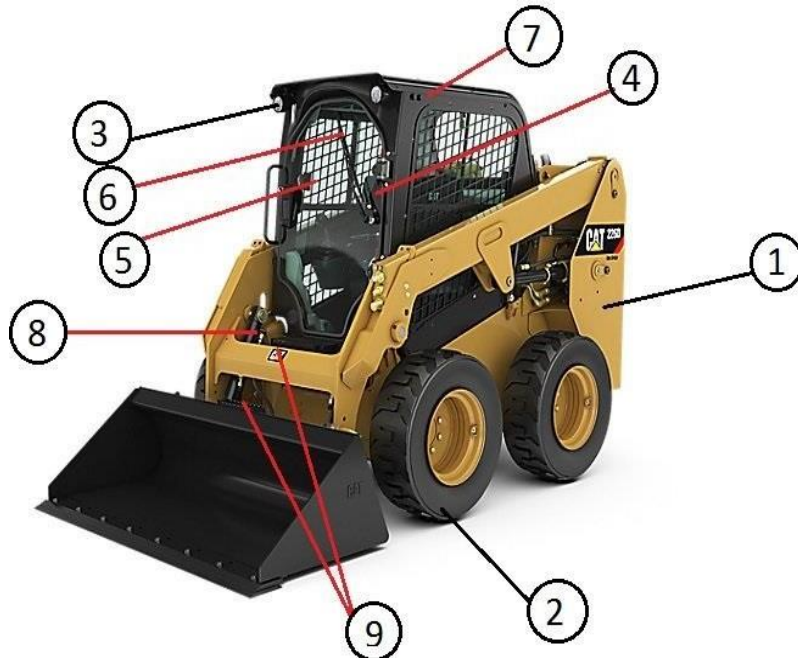

FIT <input type="checkbox"/>	PARTIALLY FIT <input type="checkbox"/>	UNFIT <input type="checkbox"/>
Inspected By		Reviewed By
Name:		Name:
Signature with date:		Signature with date:



ISGEC Heavy Engineering Limited

Checklist for Equipment Inspection

Project Name:
Checklist No.
Make:
 ISGEC

Project Code:
Date:
Model:
 Contractor

Hired

Equipment Name & Number:		35-GRADER &		
Note: Please write Yes or No in the given box and if some comments write in remarks column.				
SN.	Description		Yes/No	Remarks
1.	Machine should be physically good & should have valid TPI certificate.	#		
2.	No damage in tire (Bolts, crack, cuts & air pressure, etc.).	#		
3.	Head & tail light and indicators are in working condition.	#		
4.	Side mirror should be in good condition.	#		
5.	Wind shield/glass should be in proper condition.	#		
6.	Wiper should be in running condition.			
7.	Canopy above driver seat should be made by good & sound quality of material.	#		
8.	Hydraulic cylinders should be in good condition and free from leakage.	#		
9.	Red triangle/reflective tape should be fixed in front of vehicle.			
10.	Front & revers horn.	#		
11.	Fire extinguisher in operator cabin.	#		
12.	Operator have suitable license.	#		

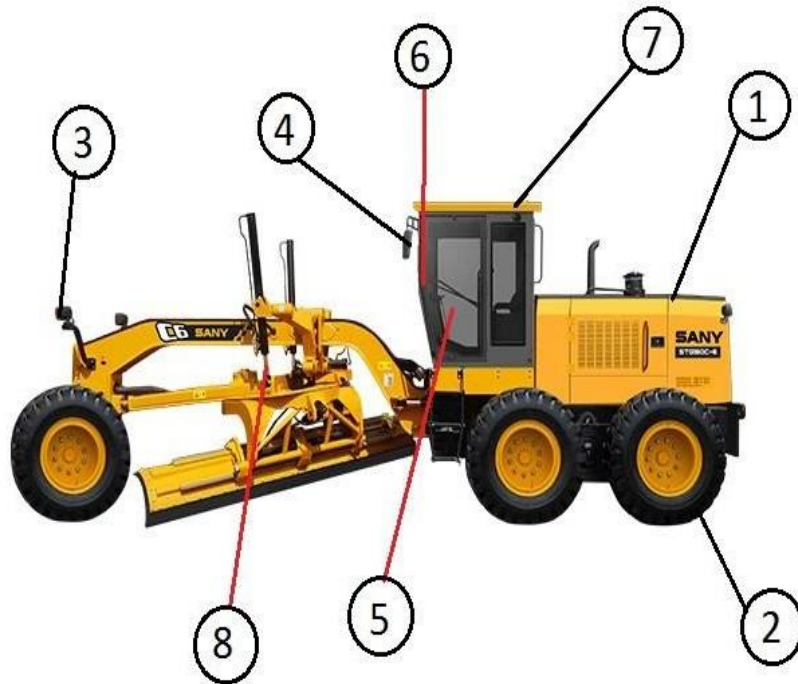

FIT <input type="checkbox"/>	PARTIALLY FIT <input type="checkbox"/>	UNFIT <input type="checkbox"/>
Inspected By		Reviewed By
Name:		Name:
Signature with date:		Signature with date:



ISGEC Heavy Engineering Limited

Checklist for Equipment Inspection

Project Name:
Checklist No.
Make:
 ISGEC

Project Code:
Date:
Model:
 Contractor

Hired

Equipment Name & Number:		36-GANTRY CRANE &		
Note: Please write Yes or No in the given box and if some comments write in remarks column.				
SN.	Description	#	Yes/No	Remarks
1.	Machine should be physically good & Should have valid TPI certificate.	#		
2.	SWL should be visible on either side.	#		
3.	Walkaway should be in good condition and free from obstruction.			
4.	Access ladder should be provided with cage.	#		
5.	Proximity sensor should be in working condition.	#		
6.	Operator cabin should be in good condition and clean.	#		
7.	Wire sling should be free from damage.	#		
8.	Hook latch must be installed in hook.	#		
9.	Guardrail system should be provided.	#		
10.	Rotating part of motor should be covered.	#		
11.	Wire sling drum should be under canopy.	#		
12.	Audible horn should be in working condition.	#		
13.	Fire extinguisher in operator cabin.	#		
14.	Operator have suitable license.	#		
15.	Deflection test should be carried out.	#		

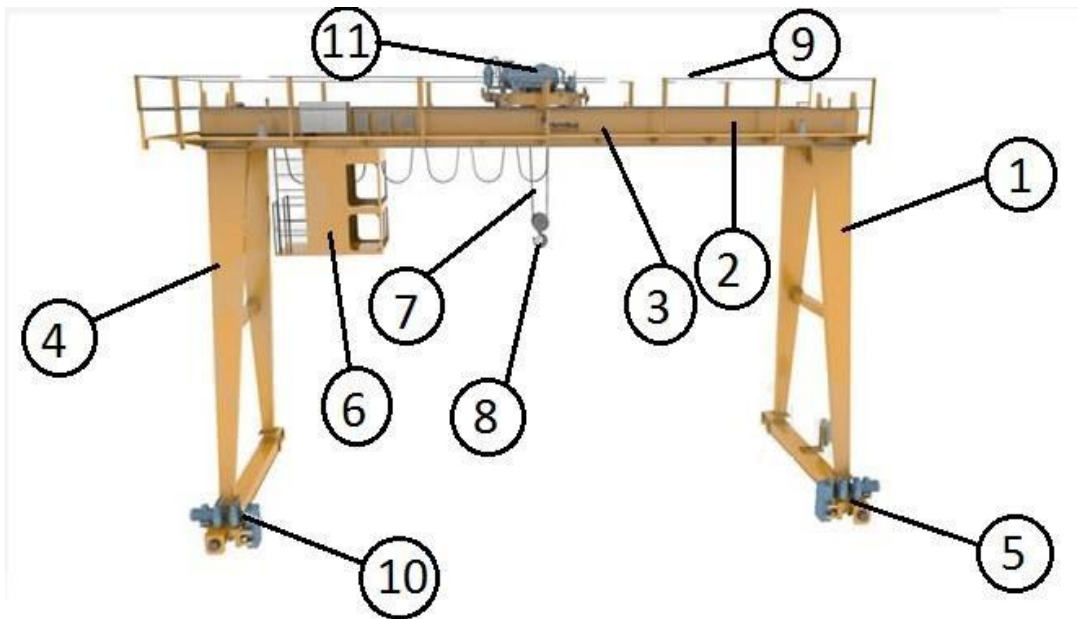

FIT <input type="checkbox"/>	PARTIALLY FIT <input type="checkbox"/>	UNFIT <input type="checkbox"/>
Inspected By	Reviewed By	
Name:	Name:	
Signature with date:	Signature with date:	



ISGEC Heavy Engineering Limited

Checklist for Equipment Inspection

Project Name:
Checklist No.
Make:
 ISGEC

Hired

Project Code:
Date:
Model:
 Contractor

Equipment Name & Number:		37-EOT CRANE &		
Note: Please write Yes or No in the given box and if some comments write in remarks column.				
SN.	Description	#	Yes/No	Remarks
1.	Machine should be physically good & should have valid TPI certificate.	#		
2.	SWL should be visible on either side.	#		
3.	Wire sling should be free from damage.	#		
4.	Hook latch must be installed in hook.	#		
5.	Power cable should be free from defect.	#		
6.	Remote should be in good condition.	#		
7.	Audible horn should be in working condition.	#		
8.	Operator have suitable license/experience certificate.	#		
9.	Deflection test should be carried out.	#		
10.	Safe access and egress should be provided.	#		

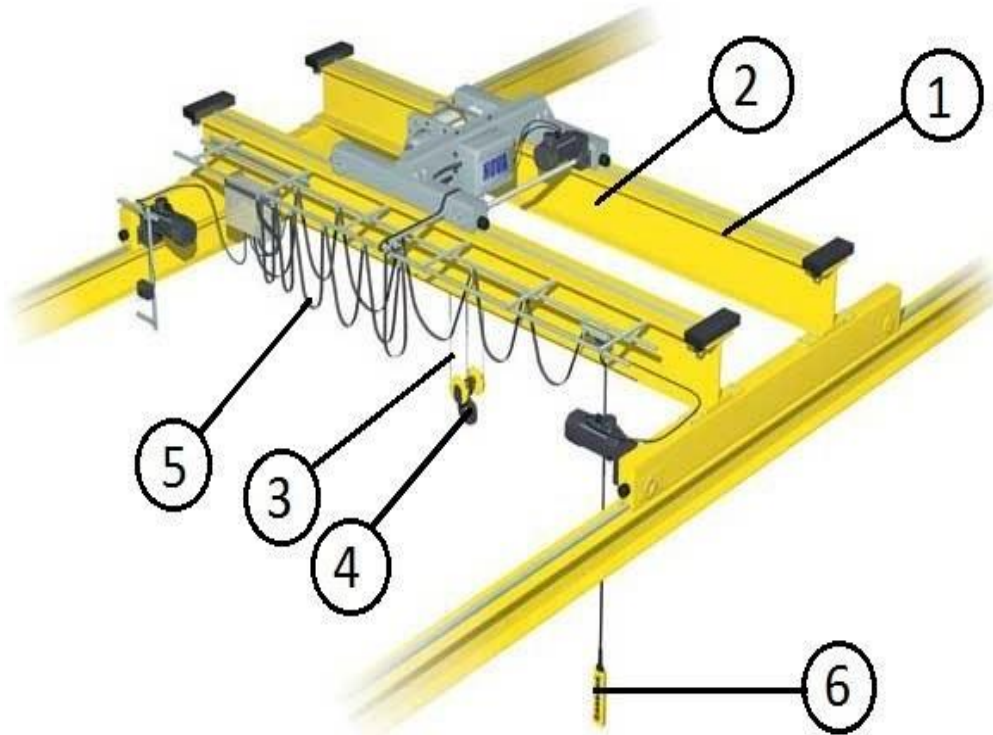

FIT <input type="checkbox"/>	PARTIALLY FIT <input type="checkbox"/>	UNFIT <input type="checkbox"/>
Inspected By	Reviewed By	
Name:	Name:	
Signature with date:	Signature with date:	



ISGEC Heavy Engineering Limited

Checklist for Equipment Inspection

Project Name:

Project Code:

Checklist No.

Date:

Make:

Model:

ISGEC

Hired

Contractor

Equipment Name & Number:		39-Trailer &		
Note: Please write Yes or No in the given box and if some comments write in remarks column.				
SN.	Description		Yes/No	Remarks
1.	Operator cabin should be fully covered and made by sound quality of material.	#		
2.	Carrier should be in good condition.	#		
3.	No damage in tire (Bolts, crack, cuts & air pressure, etc.).	#		
4.	Side mirror should be in good condition.	#		
5.	Head & tail light and indicators are in working condition.	#		
6.	Wiper should be in running condition.			
7.	Wind shield/glass should be in proper condition.	#		
8.	Seatbelt should be available.	#		
9.	Red triangle/reflective tape should be fixed in front of vehicle.			
10.	Registration number should be written.	#		
11.	Front & reverse horn.	#		
12.	Fire extinguisher in operator cabin.	#		
13.	Operator have valid and suitable license.	#		
14.	First aid kit should be available.			
15.	Normal break & emergency (hand) break should be in functional & operational condition.	#		

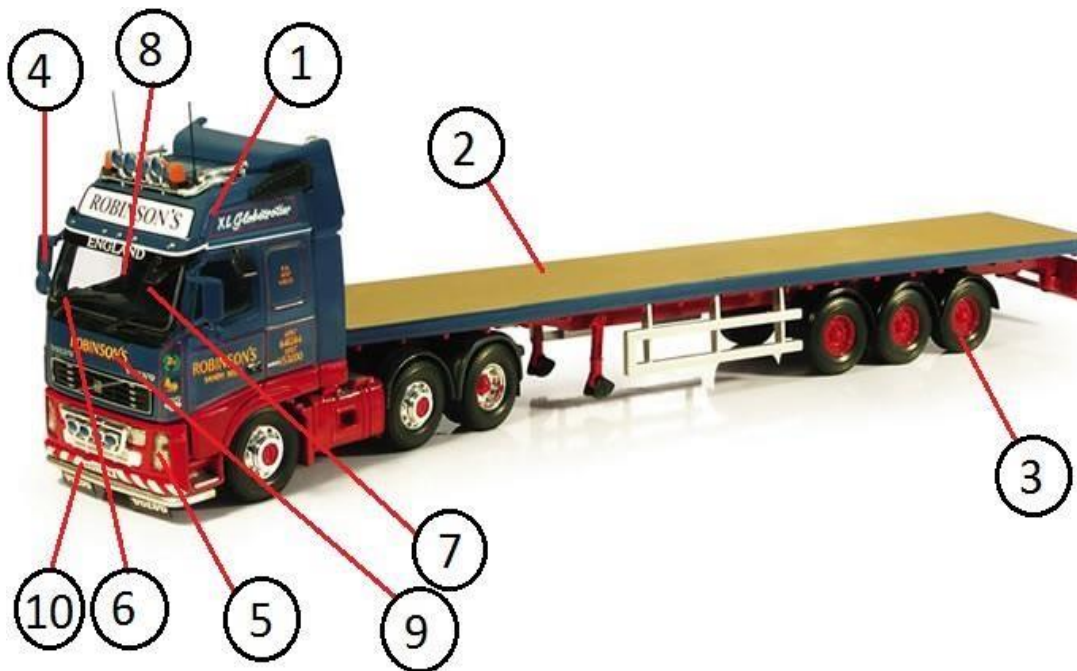

FIT <input type="checkbox"/>	PARTIALLY FIT <input type="checkbox"/>	UNFIT <input type="checkbox"/>
Inspected By		Reviewed By
Name:		Name:
Signature with date:		Signature with date:



ISGEC Heavy Engineering Limited

Checklist for Equipment Inspection

Project Name:
Checklist No.
Make:
 ISGEC

Project Code:
Date:
Model:
 Contractor

Hired

Equipment Name & Number:		40-Four Wheeler &		
Note: Please write Yes or No in the given box and if some comments write in remarks column.				
SN.	Description		Yes/No	Remarks
1.	Physical condition of vehicle is good.	#		
2.	No damage in tire (Bolts, crack, cuts & air pressure, etc.).	#		
3.	Side mirror should be in good condition.	#		
4.	Head & tail light and indicators are in working condition.	#		
5.	Wiper should be in running condition.			
6.	Wind shield/glass should be in proper condition.	#		
7.	Seatbelt should be available.	#		
8.	Reflective tape should be fixed in front of vehicle.			
9.	Registration number should be written.	#		
10.	Door lock are good condition.	#		
11.	Front & reverse horn.	#		
12.	Fire extinguisher in operator cabin.	#		
13.	Operator have valid and suitable license.	#		
14.	First aid kit should be available.			
15.	Normal break & emergency (hand) break should be in functional & operational condition.	#		

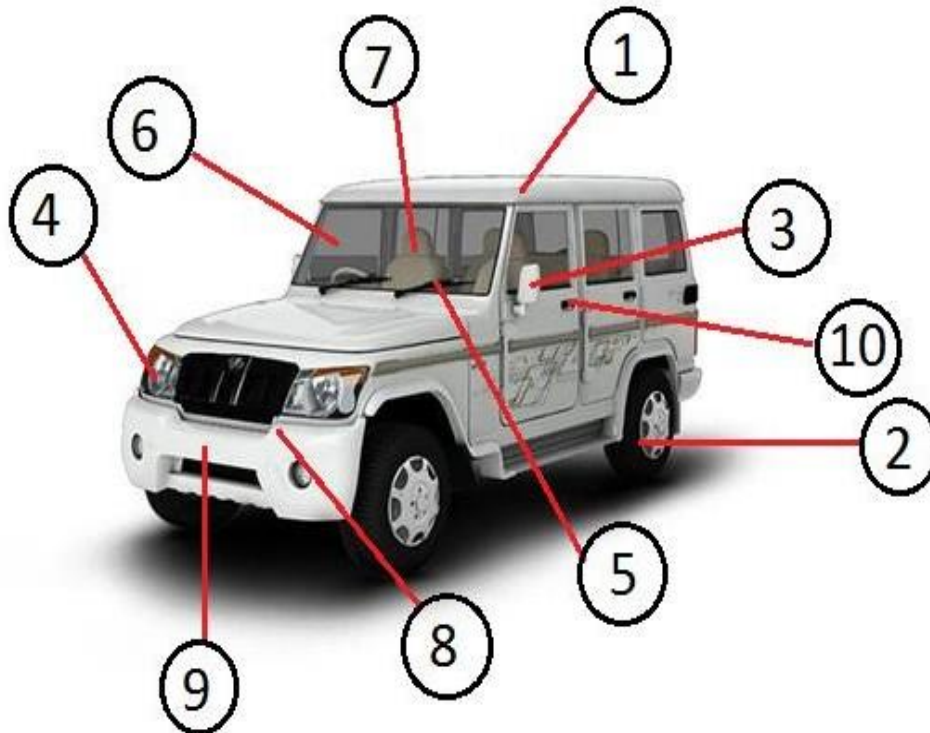

FIT <input type="checkbox"/>	PARTIALLY FIT <input type="checkbox"/>	UNFIT <input type="checkbox"/>
Inspected By		Reviewed By
Name:		Name:
Signature with date:		Signature with date:



ISGEC Heavy Engineering Limited

Checklist for Equipment Inspection

Project Name:

Checklist No.

Make:

ISGEC

Hired

Project Code:

Date:

Model:

Contractor

Equipment Name & Number:		41-Bus &		
Note: Please write Yes or No in the given box and if some comments write in remarks column.				
SN.	Description		Yes/No	Remarks
1.	Physical condition of vehicle is good.	#		
2.	No damage in tire (Bolts, crack, cuts & air pressure, etc.).	#		
3.	Side mirror should be in good condition.	#		
4.	Head & tail light and indicators are in working condition.	#		
5.	Wiper should be in running condition.			
6.	Wind shield/glass should be in proper condition.	#		
7.	Seatbelt should be available.	#		
8.	Reflective tape should be fixed in front of vehicle.			
9.	Registration number should be written.	#		
10.	Door lock are good condition.	#		
11.	Front & reverse horn.	#		
12.	Fire extinguisher in operator cabin.	#		
13.	Operator have valid and suitable license.	#		
14.	First aid kit should be available.			
15.	Normal break & emergency (hand) break should be in functional & operational condition.	#		

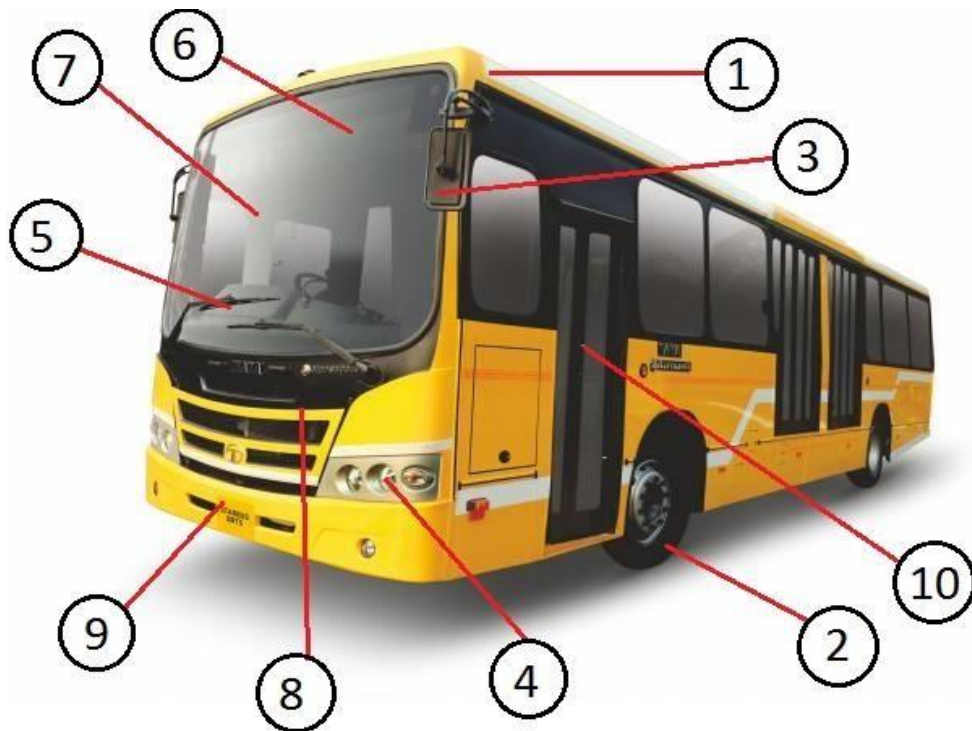

FIT <input type="checkbox"/>	PARTIALLY FIT <input type="checkbox"/>	UNFIT <input type="checkbox"/>
Inspected By		Reviewed By
Name:		Name:
Signature with date:		Signature with date:



ISGEC Heavy Engineering Limited

Checklist for Equipment Inspection

Project Name:
Checklist No.
Make:
 ISGEC

Hired

Project Code:
Date:
Model:
 Contractor

Equipment Name & Number: 42-Diesel Tanker &			
Note: Please write Yes or No in the given box and if some comments write in remarks column.			
SN.	Description	Yes/No	Remarks
1.	Physical condition of vehicle is good and free from leakage.	#	
2.	No damage in tire (Bolts, crack, cuts & air pressure, etc.).	#	
3.	Side mirror should be in good condition.	#	
4.	Head & tail light and indicators are in working condition.	#	
5.	Wiper should be in running condition.		
6.	Wind shield/glass should be in proper condition.	#	
7.	Seatbelt should be available.	#	
8.	Red triangle/Reflective tape has fixed in front of vehicle.		
9.	Registration number should be written.	#	
10.	HAZCHEM code visibly written.	#	
11.	NFPA diamond Visibly written.	#	
12.	Front & reverse horn.	#	
13.	Fire extinguisher in operator cabin.	#	
14.	Operator have valid and suitable license.	#	
15.	First aid kit should be available.	#	
16.	Spill observant kit/drip tray available.	#	
17.	TERM card and MSDS available.	#	
18.	Emergency contact number available.	#	
19.	Normal break & emergency (hand) break should be in functional & operational condition.	#	

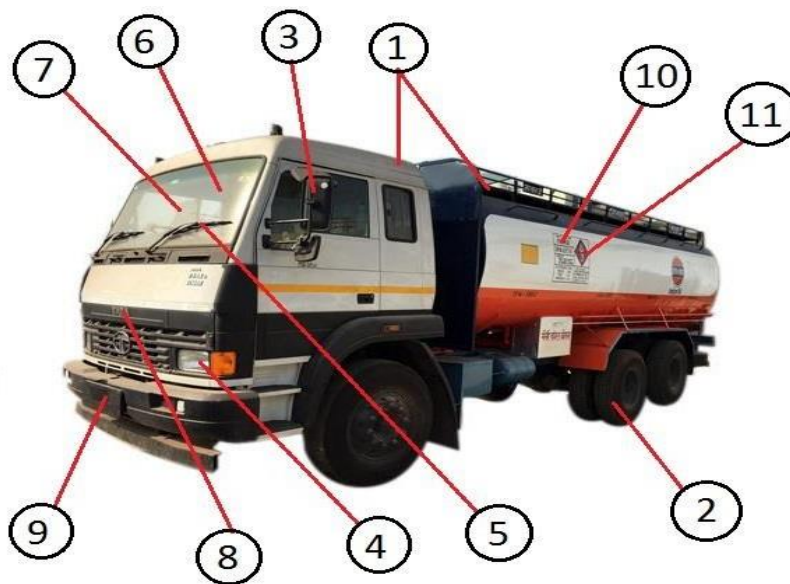

FIT <input type="checkbox"/>	PARTIALLY FIT <input type="checkbox"/>	UNFIT <input type="checkbox"/>
Inspected By		Reviewed By
Name:		Name:
Signature with date:		Signature with date:



ISGEC Heavy Engineering Limited

Checklist for Equipment Inspection

Project Name:

Checklist No.

Make:

ISGEC

Hired

Project Code:

Date:

Model:

Contractor

Equipment Name & Number:		43-Water Tanker &		
Note: Please write Yes or No in the given box and if some comments write in remarks column.				
SN.	Description		Yes/No	Remarks
1.	Physical condition of vehicle is good and free from leakage.	#		
2.	No damage in tire (Bolts, crack, cuts & air pressure, etc.).	#		
3.	Side mirror should be in good condition.	#		
4.	Head & tail light and indicators are in working condition.	#		
5.	Wiper should be in running condition.			
6.	Wind shield/glass should be in proper condition.	#		
7.	Seatbelt should be available.	#		
8.	Red triangle/Reflective tape should be fixed in front of vehicle.			
9.	Registration number should be written.	#		
10.	Front & reverse horn.	#		
11.	Fire extinguisher in operator cabin.	#		
12.	Operator have valid and suitable license.	#		
13.	First aid kit should be available.			
14.	Normal break & emergency (hand) break should be in functional & operational condition.	#		



FIT <input type="checkbox"/>	PARTIALLY FIT <input type="checkbox"/>	UNFIT <input type="checkbox"/>
Inspected By		Reviewed By
Name:		Name:
Signature with date:		Signature with date:



ISGEC Heavy Engineering Limited

Checklist for Equipment Inspection

Project Name:
Checklist No.
Make:
 ISGEC

Project Code:
Date:
Model:
 Contractor

Hired

Equipment Name & Number:		71-Bike &		
Note: Please write Yes or No in the given box and if some comments write in remarks column.				
SN.	Description		Yes/No	Remarks
1.	Physical condition of vehicle is good.	#		
2.	No damage in tire (crack, cuts & air pressure, etc.).	#		
3.	Side mirror should be in good condition.	#		
4.	Head light and indicators are in working condition.	#		
5.	Registration number should be written.	#		
6.	Stand should be in proper condition.	#		
7.	Horn is in working condition.	#		
8.	Rider have valid and suitable license.	#		
9.	Rider is using crash helmet during riding.			
10.	First aid kit should be available.			
11.	Break should be in functional & operational condition.	#		



FIT <input type="checkbox"/>	PARTIALLY FIT <input type="checkbox"/>	UNFIT <input type="checkbox"/>
Inspected By		Reviewed By
Name:		Name:
Signature with date:		Signature with date: